



**MODULAR XL**  
FLAT WALL MOUNTS

---

**FOR EXTRA LARGE  
FLAT DISPLAYS**

# Modular XL wall mounts

Vogel's Professional introduces a new range of modular wall mounts for extra large displays. The modular wall mount is especially designed for displays from 65 inches and larger, with a maximum mounting fitment of 1370x1400 mm and maximum weight of 160 kg.

The modular wall mount is set up with an interface wall plate (PFW 58xx) and two interface strips (PFW 59xx). Vogel's offers 3 different lengths of interface wall plates 800, 1050 and 1450 mm and 3 different lengths of interface strips 800, 950 and 1450 mm. With this modular concept you can create a mounting solution for almost every extra large display.

## Features are:

- Landscape and portrait position
- Built in levelling function for quicker installation
- Service position for easy connecting cables after installation
- Security option: possibility to add a padlock



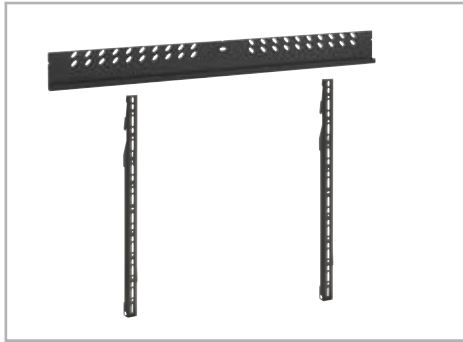

**Modular: always create a fit**

With the modular concept you can create your own wall mount for almost every display. Different sizes of interface wall plates and interface strips are available. Landscape and portrait position possible.

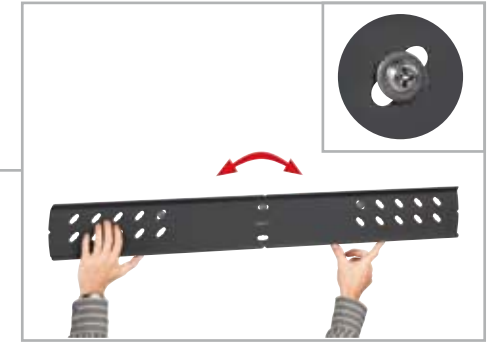

**Easy levelling and installation**

Special diagonal mounting holes make it very easy to level the interface wall plate during installation. You can even fine tune it after installation.



**Security option**

Security option available to safeguard displays and prevent unauthorized removal (clip included, padlock not included).

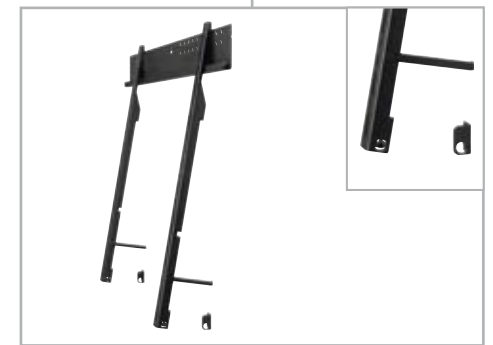

**Service position**

Cables can be easily connected after installation.

# INTERFACE WALL PLATES

**PFW 5808**

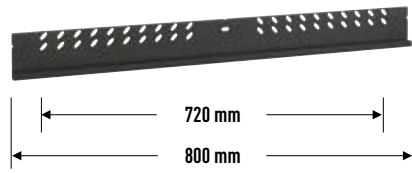

- Length interface wall plate: 800 mm
- Max fitment: 720 mm
- Max load: 160 kg
- Built-in level function

**PFW 5810**

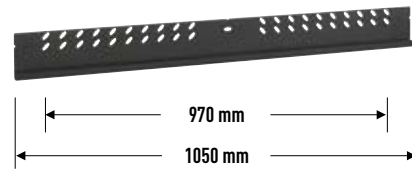

- Length interface wall plate: 1050 mm
- Max fitment: 970 mm
- Max load: 160 kg
- Built-in level function

**PFW 5814**

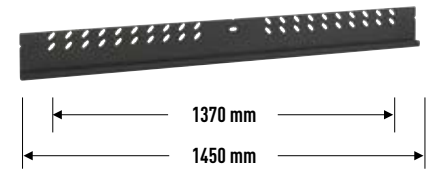

- Length interface wall plate: 1450 mm
- Max fitment: 1370 mm
- Max load: 160 kg
- Built-in level function

+

# INTERFACE STRIPS

**PFW 5908**

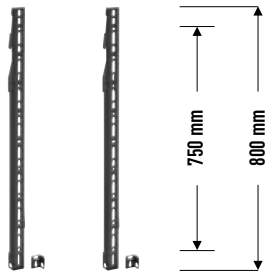

- Length interface strips: 800 mm
- Max fitment: 750 mm
- Max load: 160 kg
- Service position
- Security option

**PFW 5909**

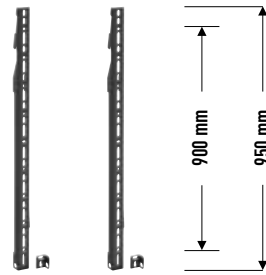

- Length interface strips: 950 mm
- Max fitment: 900 mm
- Max load: 160 kg
- Service position
- Security option

**PFW 5914**

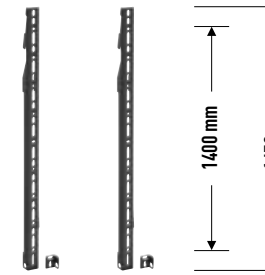

- Length interface strips: 1450 mm
- Max fitment: 1400 mm
- Max load: 160 kg
- Service position
- Security option

=

# XL WALL MOUNT



Request our extensive catalogue with our entire range of solutions: [www.vogels.com/profcats](http://www.vogels.com/profcats)



PX 20049 © 10/2010 Vogel's Holding BV 2010 © all rights reserved.

## STEPS

## MODULAR XL WALL MOUNTS

### WALL

### STEP 1

INTERFACE  
WALL  
PLATE



800 mm

1050 mm

1450 mm

PFW 5808

PFW 5810

PFW 5814

### STEP 2

INTERFACE  
DISPLAY  
STRIPS



500 mm

PFW 5905



800 mm

PFW 5908



950 mm

PFW 5909



1450 mm

PFW 5914

